

Article number: 3902210015260

Description: Worm gear
VF 210-A-15-180B5, without lubrication

Measures

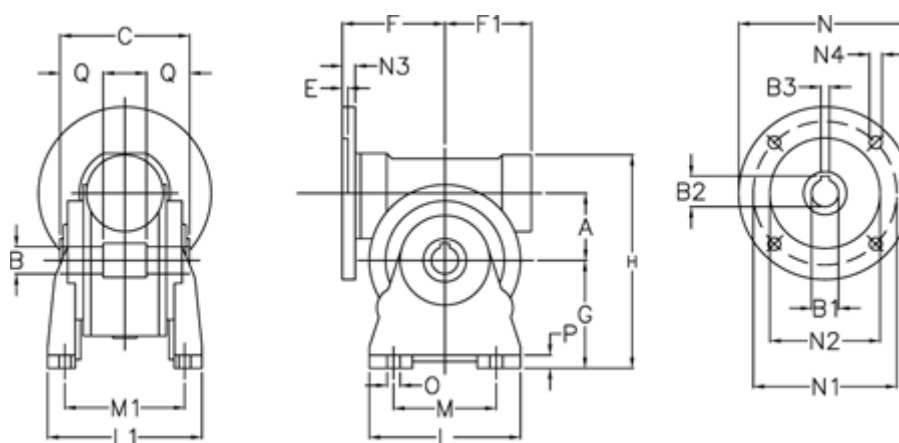

A	= 210	F1	= 277	N1	= 300
B	= 90 H7	G	= 335	N2	= 250
B1 E7	= 48	H	= 665	N3	= 22
B2	= 51.8	L	= 440	N4	= 18
B3 H9	= 14	L1	= 320	O	= 26
C	= 260	M	= 340	P	= 25
E	= 8	M1	= 265	Q	= 85
F	= 460	N	= 350		